

IDEAL WORKSTATION 6 - DOUBLE BOWL (IWS 6-D)
INSTALLATION & COUNTER TOP CUTOUT

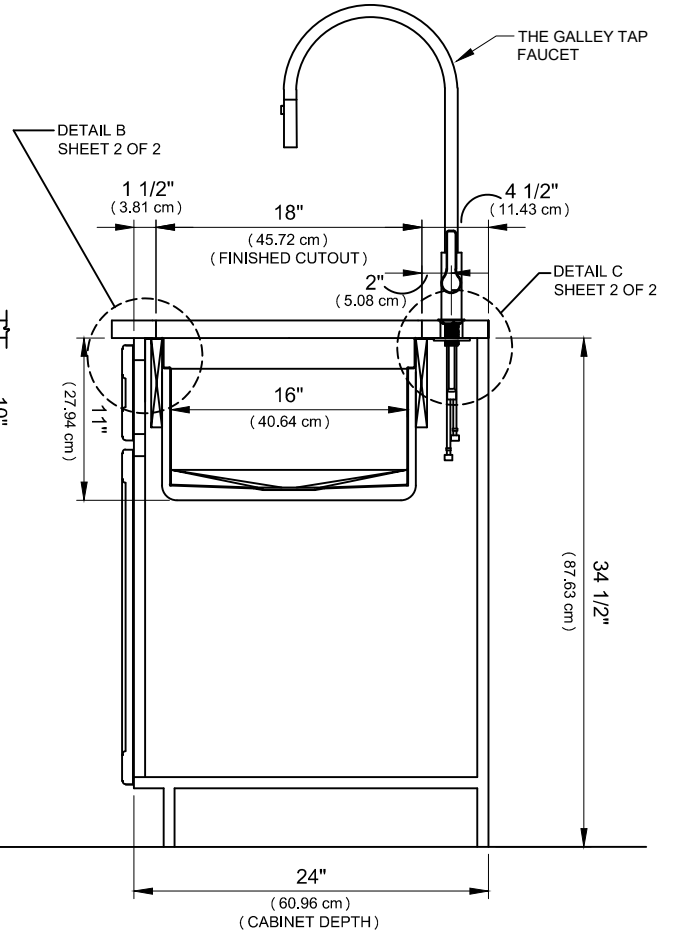
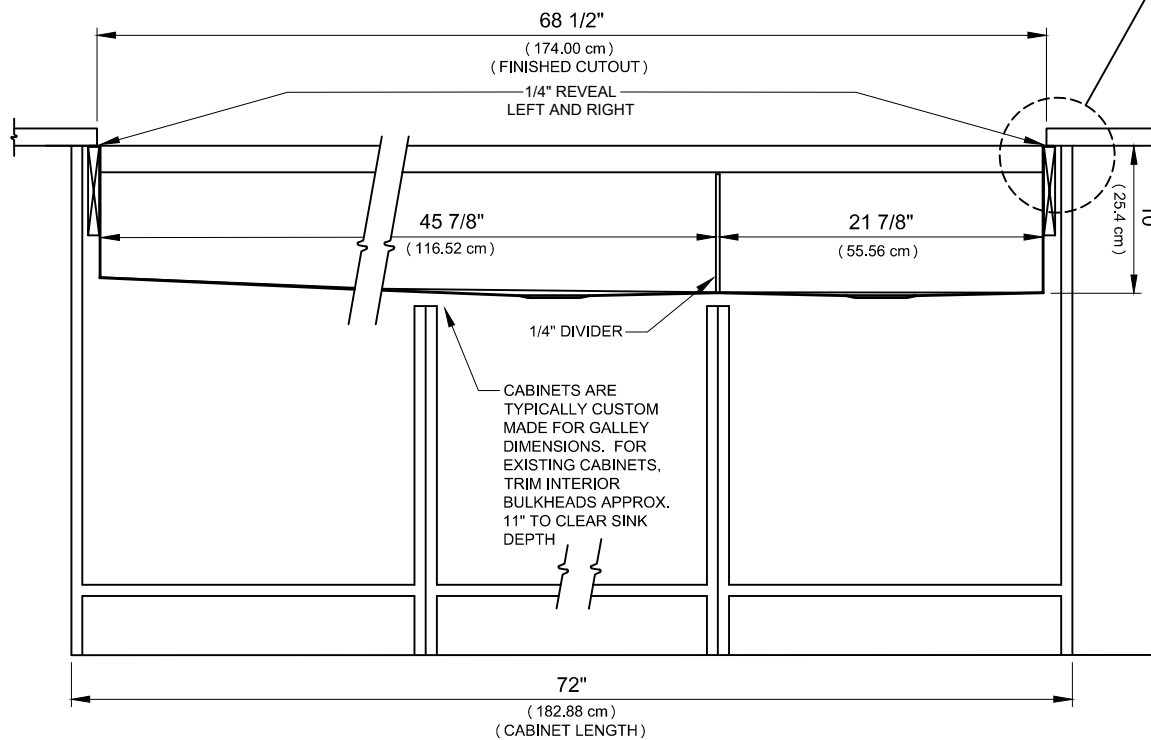
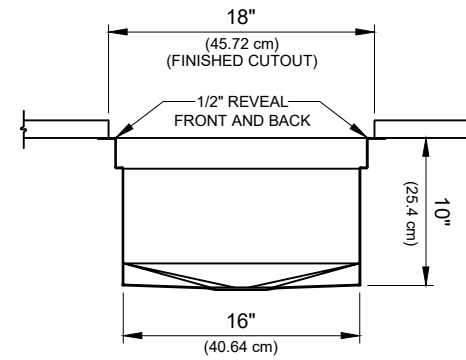
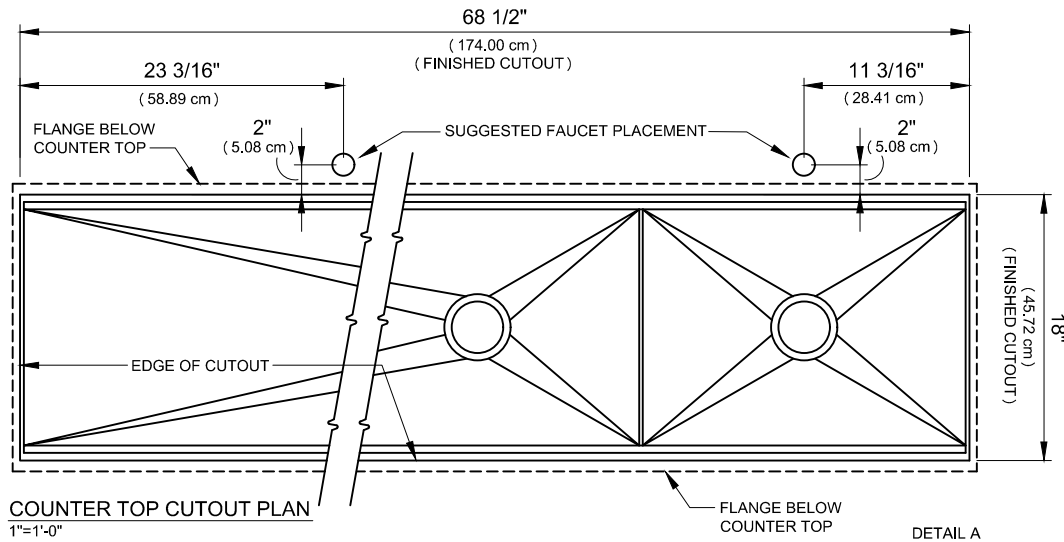

INSTALLATION AND COUNTER TOP CUTOUT DETAIL
 SHEET 1 OF 2

STAINLESS STEEL COMPLIANCE ASME A112.19.3-2008/CSA B45.4-08

WE RESERVE THE RIGHT TO MAKE REVISIONS WITHOUT NOTICE IN THE DESIGN OF PRODUCTS OR IN PACKAGING UNLESS THIS RIGHT HAS SPECIFICALLY BEEN WAIVED AT THE TIME THE ORDER IS ACCEPTED.

IWS-6-D
 DOUBLE BOWL

THE GALLEY
 REINVENT YOUR KITCHEN
 THEGALLEY.COM

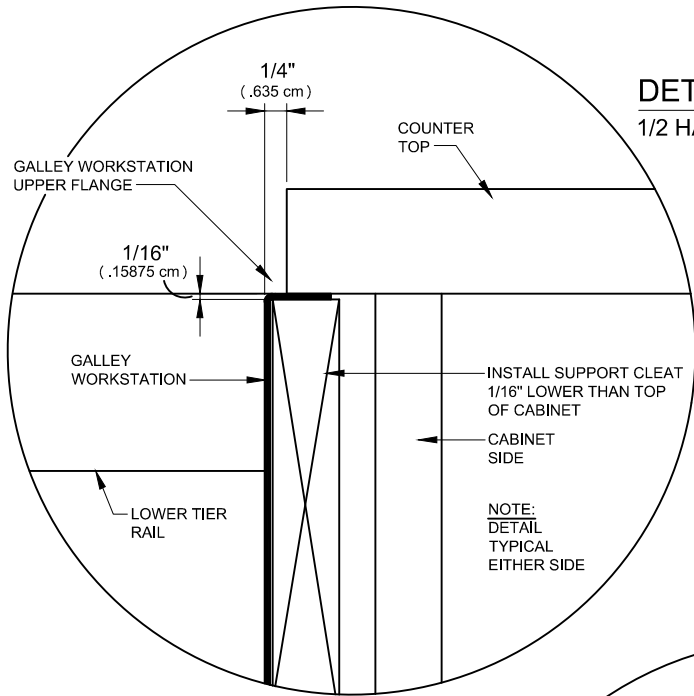

DETAIL A
 1/2 HALF FULL SIZE

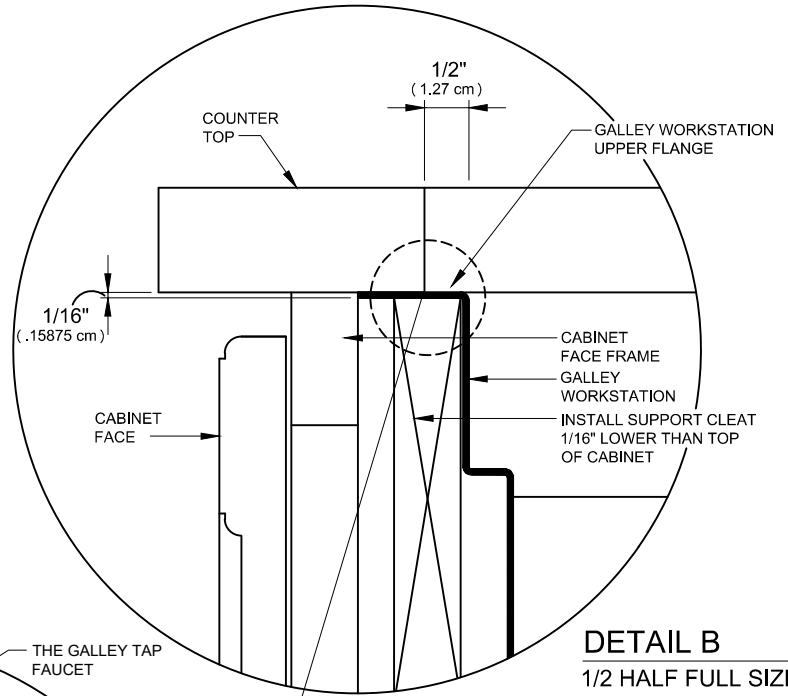

DETAIL B
 1/2 HALF FULL SIZE

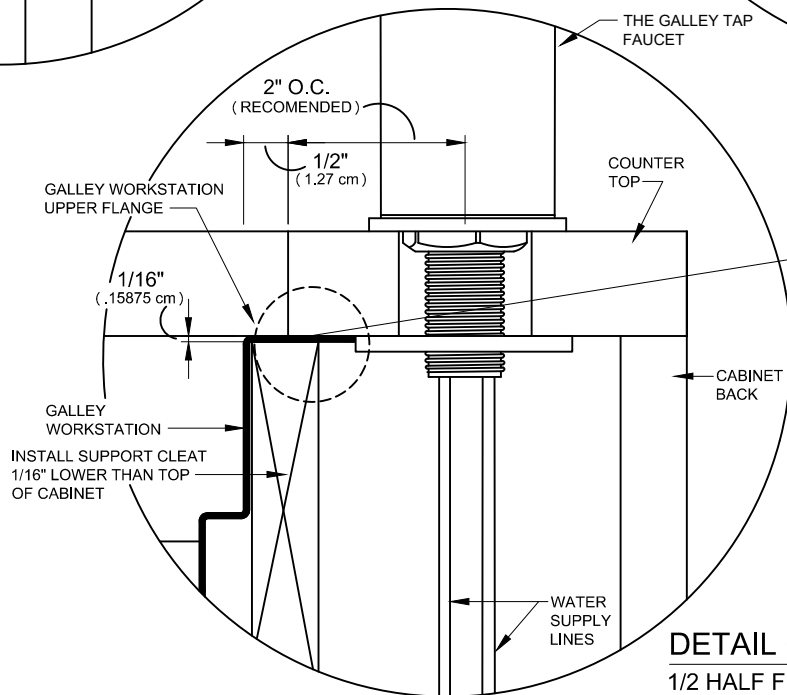

DETAIL C
 1/2 HALF FULL SIZE

- FOR A SILICONE-FREE FLANGE:**
1. COVER WHAT WILL BE THE EXPOSED 1/2" OF TOP FLANGE WITH TAPE.
 2. APPLY A HEAVY BEAD OF SILICONE TO THE UN-TAPED PART OF THE FLANGE.
 3. SET THE COUNTER TOP, PRESS DOWN ONTO THE FLANGE. THE SILICONE SHOULD FILL ANY GAPS.
 4. WIPE EXCESS SILICONE OFF OF EXPOSED FLANGE.
 5. REMOVE TAPE

IWS-6-D
 DOUBLE BOWL

INSTALLATION AND COUNTER TOP CUTOUT DETAIL
 SHEET 2 OF 2

STAINLESS STEEL COMPLIANCE ASME A112.19.3-2008/CSA B45.4-08

WE RESERVE THE RIGHT TO MAKE REVISIONS WITHOUT NOTICE IN THE DESIGN OF PRODUCTS OR IN PACKAGING UNLESS THIS RIGHT HAS SPECIFICALLY BEEN WAIVED AT THE TIME THE ORDER IS ACCEPTED.